

STITCH 100



NAVE 101



PXL 102



SPJUTET 103



FOTO 104



BOX ONE 105



595 106-107



VIVA 108



ALLRIGHT 109



STREAM 110



UPPSALA 111



ARCAD 112-114



WOOD 98



TOP 99



MIMMI 115



KEPS 116





**Utförande:** Oljad alt. svartbetsad ekfanér. Bländskydd av matt akryl, vid metallhalogen klart täckglas Kan även tillverkas i andra träslag och ytbehandlingar på begäran. Finns med ett flertal olika ljuskällor. 26-32W kompaktlysrör, 35W metallhalogen alt. LED Philips Fortimo 2000 lumen med ljusfärg 830 alt. 840.

**Montage:** På vägg, kan monteras i önskad riktning.

**Anslutning:** Kopplingsplint 5x4mm<sup>2</sup>.

**Design:** Fredrik Mattson 2010.

W	FÄRG/FINISH	ART.
26-32W/Gx24q	Oljad ek/Oiled oak	8030-1-32
32W/Gx24q	Oljad ek/Oiled oak	8030-1-32HFF
35W/G12	Oljad ek/Oiled oak	8031-1-32
LED/2000Lm/830	Oljad ek/Oiled oak	8032-1-32
LED/2000Lm/840	Oljad ek/Oiled oak	8033-1-32
26-32W/Gx24q	Svart ek/Black oak	8030-1-36
32W/Gx24q	Svart ek/Black oak	8030-1-36HFF
35W/G12	Svart ek/Black oak	8031-1-36
LED/2000Lm/830	Svart ek/Black oak	8032-1-36
LED/2000Lm/840	Svart ek/Black oak	8033-1-36

HFF = Dimmbart Driftdon. Fördunklas via SwitchDIM alt. DSI Dali på begäran  
HFF = Dimmable ballast. Dimmable with Switch-DIM or DSI. Dali on request.

**Finish:** Oiled oak veneer natural or black stained. Matt acrylic diffuser. When metal halide clear glass. Available in other wood finishes and stains on request. Available with several light sources. 26-32W compact fluorescent, 35W metal halide and LED Philips Fortimo 2000 lumen in light-color 830 or 840.

**Installation:** On wall, can be installed in different directions.

**Connection:** Terminal block 5x4mm<sup>2</sup>.

**Design:** Fredrik Mattson 2010.

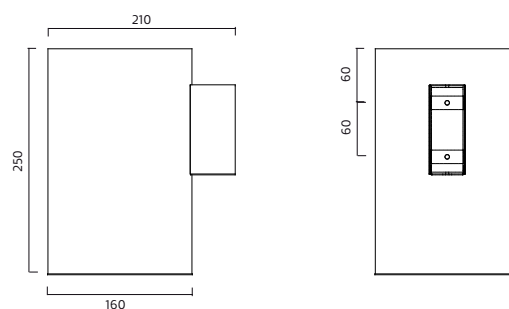

TAK/CEILING 48-49

PENDLAR/PENDANTS 98

BORD/TABLE 130

**Utförande:** Vit- alt. svartlackerad metall. Inbyggd transformator.

**Montage:** Vägg- eller takmontage.

**Anslutning:** Kopplingsplint 2x2,25 mm<sup>2</sup>. Utbrytningshål för utanpåliggande ledning.

**Design:** Tham & Videgård 2009.

W	FÄRG/FINISH	ART
35W/Gu5,3	Vit/White	7851-1-01
35W/Gu5,3	Svart/Black	7851-1-06

**Finish:** White or black painted metal. Transformer included.

**Installation:** On wall or ceiling.

**Connection:** Terminal block 2x2,25 mm<sup>2</sup>. Knock-out for rim cable.

**Design:** Tham & Videgård 2009.

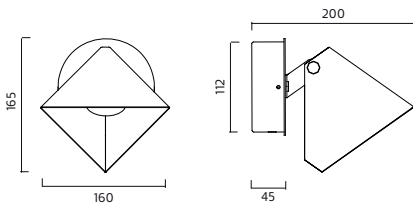



Konstruktion och design är inspirerad av samma princip som en broderiram. När den är monterad på vägg eller i tak är det möjligt att justera skärmen i olika lägen för att rikta ljuset i önskad riktning.

**Utförande:** Lackerad aluminium och matt akryl. Vinklingsbar.

**Montage:** Dikt vägg eller tak.

**Anslutning:** Snabbkopplingsplint 5x4mm<sup>2</sup>.

**Design:** Mattias Ståhlbom 2010.

W	D	FÄRG/FINISH	ART
22W/2Gx13	300	Vit/White	8070-1-01
22W/2Gx13	300	Vit/White	8070-1-01HFF
22W/2Gx13	300	Svart/Black	8070-1-06
22W/2Gx13	300	Svart/Black	8070-1-06HFF
22W/2Gx13	300	Röd/Red	8070-1-07
22W/2Gx13	300	Röd/Red	8070-1-07HFF
40W/2Gx13	400	Vit/White	8070-3-01
40W/2Gx13	400	Vit/White	8070-3-01HFF
40W/2Gx13	400	Svart/Black	8070-3-06
40W/2Gx13	400	Svart/Black	8070-3-06HFF
40W/2Gx13	400	Röd/Red	8070-3-07
40W/2Gx13	400	Röd/Red	8070-3-07HFF

HFF = Dimmbart driftdon. Fördunklas med SwitchDim alt. DSI. Dali på begäran.

HFF = Dimmable ballast. Dimmable with SwitchDim or DSI. Dali on request.

*The construction and the appearance of the lamp are inspired by the same principle as an embroidery frame. When attached to the wall or ceiling it is possible to adjust the frame to different angles to direct the light and gain the most effect from the light source and the lamp.*

**Finish:** Painted metal and matt opal acrylic. For T5 circular tube.

**Installation:** On ceiling or on wall.

**Connection:** Terminal block 5x4mm<sup>2</sup>

**Design:** Mattias Ståhlbom 2010.

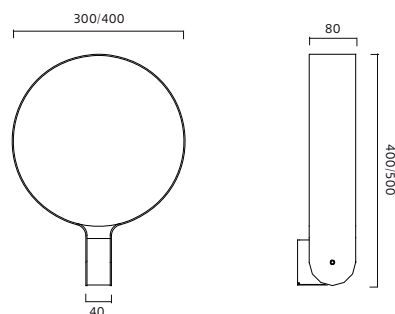

**Utförande:** Lackerad metall och opal akryl.

**Montage:** Dikt vägg.

**Anslutning:** Snabbkopplingsplint 5x4mm<sup>2</sup>. Utbrytningshål för utanpåliggande kabel. Överkopplingsbar.

**Design:** Formfjord 2010.

W	SKÄRM/SHADE	ART NR
24W/2G11	Vit/White	8050-1-01
24W/2G11	Vit/White	8050-1-01HFF
24W/2G11	Grå/Grey	8050-1-26
24W/2G11	Grå/Grey	8050-1-26HFF

HFF = Dimmbart Driftdon. Fördunklas via SwitchDIM alt. DSI Dali på begäran  
HFF = Dimmable ballast. Dimmable with Switch-DIM or DSI. Dali on request

**Finish:** White or grey painted metal. Diffuser in opal acrylic.

**Installation:** On wall.

**Connection:** Terminal block 5x4mm<sup>2</sup>. Knock-out for rim cable. Two entry holes.

**Design:** Formfjord 2010.

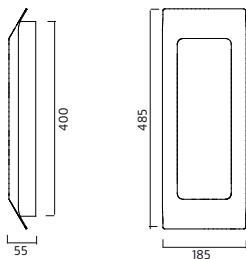



**Utförande:** Vitlackerad metall alt. galvaniserad metall.

**Montage:** Dikt vägg.

**Anslutning:** Snabbkopplingsplint 3x4mm<sup>2</sup>. Utbrytningshål för utanpåliggande kabel ovanifrån.

**Design:** Fredrik Mattson.

W	FÄRG/FINISH	KG	ART
18W/Gx24q-2	Vit/White	1,5	7772-1-01
18W/Gx24q-2	Galv/Galvanized	1,5	7772-1-83
E27	Vit/White	1,5	7773-1-01
E27	Galv/Galvanized	1,5	7773-1-83

#### LJUSKÄLLA E27/LIGHT SOURCE E27

42W Halogen Eco	L251715
11W lågenergi/low energy	L700112
7W LED	L70023

**Finish:** White painted metal or galvanized metal.

**Installation:** On Wall.

**Connection:** Snap-in terminal block 3x4mm<sup>2</sup>. Knockout for external mains cable from above.

**Design:** Fredrik Mattson 2008.

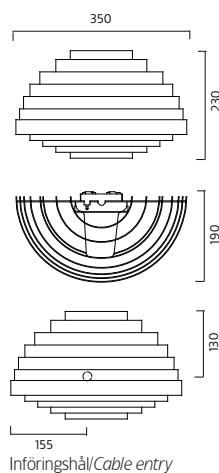

TAK/CEILING 14

PENDLAR/PENDANTS 64-65

BORD/TABLE 136

UTOMHUS/OUTDOOR 160-161

En stilren vägg- eller takspotlight. Spjut finns i olika längder, vilket ger ett brett användningsområde.

**Utförande:** Spotlight av förkromad metall. Fäste av vitlackerad metall.

**Montage:** Dikt vägg ellet tak.

**Anslutning:** Inkl. elektronisk trafo. Kopplingsplint 2x2,5mm<sup>2</sup>.

**Design:** Stig Ahlström, Claes Koch.

W	MODELL/MODEL	KG	ART
1x20-50W	Tak/vägg/ceiling/wall	0,3	5020-1-01
2x20-50W	Tak/vägg/ceiling/wall	0,4	5020-3-01
1x20-50W	Väggfäste/Wallfitting	1,2	5027-1-01
2x20-50W	Väggfäste/Wallfitting	2,4	5029-1-01
20-50W/Gu5,3	L 200	0,1	5600-1-82
20-50W/Gu5,3	L 500	0,3	5600-3-82
20-50W/Gu5,3	L 750	0,4	5600-5-82
20-50W/Gu5,3	L 1000	0,5	5600-7-82

**Finish:** White and chromed steel.

**Installation:** On ceiling, on 3-phase track or on wall.

**Connection:** Fixture incl. el-transformer. Terminal block 2x2,5mm<sup>2</sup>.

**Design:** Stig Ahlström, Claes Koch.

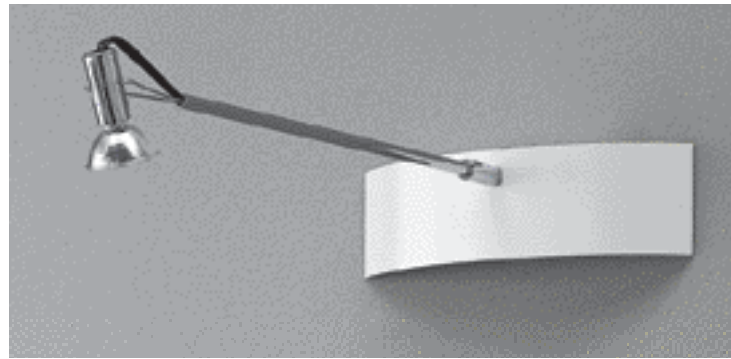
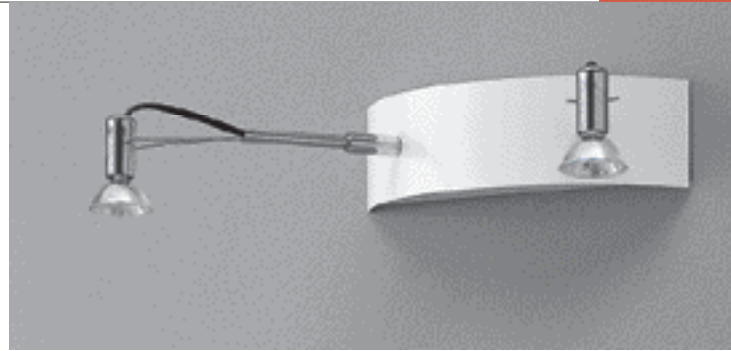
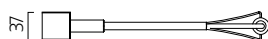
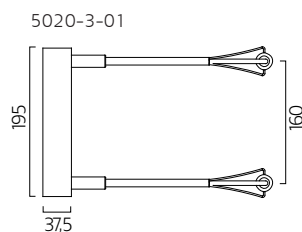
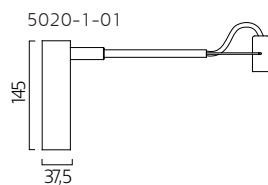
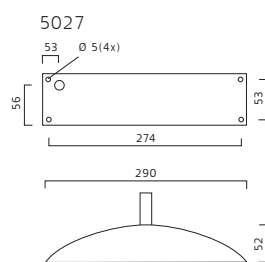
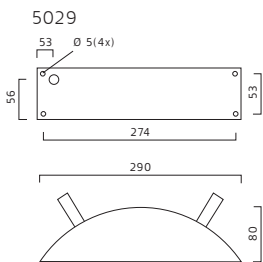
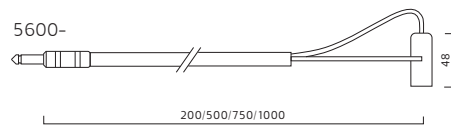
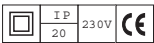

5020-1-01

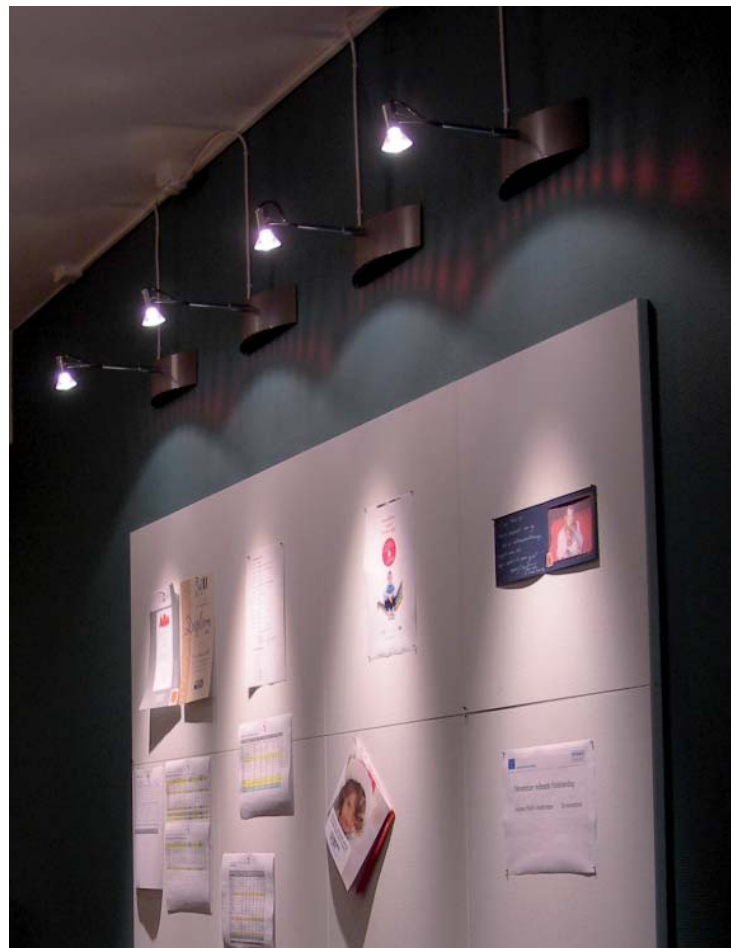



**Utförande:** Lackerad metall och gjuten aluminium. Riktbart armaturhus.

Fyra ställbara avbländningsklaffar.

**Anslutning:** Fast montage, kopplingsplint 2x2,5mm<sup>2</sup>. Alt. 2,5 m kabel med brytare och stickpropp. Svart lackerad har svart kabel, övriga har vit kabel. Dimmer på kabel finns som tillbehör.

**Design:** Thomas Bernstrand, Mattias Ståhlbom 2007.

W	MODELL/MODELL	FÄRG/FINISH	ART.
35W/GU10	Fast mont/Fixed installation	Vit/White	7655-1-01
35W/GU10	Fast mont/Fixed installation	Svart/Black	7655-1-06
35W/GU10	Fast mont/Fixed installation	Röd/Red	7655-1-07
35W/GU10	Fast mont/Fixed installation	Blå/Blue	7655-1-08
35W/GU10	Fast mont/Fixed installation	Gul/Yellow	7655-1-14
35W/GU10	Fast mont/Fixed installation	Orange/Orange	7655-1-41
35W/GU10	2,5 m kabel/2,5 m cable	Vit/White	7656-1-01
35W/GU10	2,5 m kabel/2,5 m cable	Svart/Black	7656-1-06
35W/GU10	2,5 m kabel/2,5 m cable	Röd/Red	7656-1-07
35W/GU10	2,5 m kabel/2,5 m cable	Blå/Blue	7656-1-08
35W/GU10	2,5 m kabel/2,5 m cable	Gul/Yellow	7656-1-14
35W/GU10	2,5 m kabel/2,5 m cable	Orange/Orange	7656-1-41
20W/12V	Fast mont/Fixed installation	Vit/White	7755-1-01
20W/12V	Fast mont/Fixed installation	Svart/Black	7755-1-06
20W/12V	Fast mont/Fixed installation	Röd/Red	7755-1-07
20W/12V	Fast mont/Fixed installation	Blå/Blue	7755-1-08
20W/12V	Fast mont/Fixed installation	Gul/Yellow	7755-1-14
20W/12V	Fast mont/Fixed installation	Orange/Orange	7755-1-41
20W/12V	2,5 m kabel/2,5 m cable	Vit/White	7756-1-01
20W/12V	2,5 m kabel/2,5 m cable	Svart/Black	7756-1-06
20W/12V	2,5 m kabel/2,5 m cable	Röd/Red	7756-1-07
20W/12V	2,5 m kabel/2,5 m cable	Blå/Blue	7756-1-08
20W/12V	2,5 m kabel/2,5 m cable	Gul/Yellow	7756-1-14
20W/12V	2,5 m kabel/2,5 m cable	Orange/Orange	7756-1-41

#### TILLBEHÖR/ACCESSORY

#### ART

Dimmer, vit. Endast för 35W 230 volt. Dimmer, white. For 35W 230 voltage only.	97652-1-01
Dimmer, svart. Endast för 35W 230 volt. Dimmer, Black. For 35W 230 voltage only	97652-1-06

#### ALTERNATIV LJUSKÄLLA GU10/ALTERNATIVE LIGHT SOURCE GU10

3W LED	L70024
--------	--------

**Finish:** Wall fixture with adjustable spotlight. Painted steel and die-casted aluminium.

**Installation:** Fixed installation, terminal block 2x2,5mm<sup>2</sup> or 2,5 m cable and plug. Dimmer available as accessory. Black finish has black cable, other finishes have white cable.

**Design:** Thomas Bernstrand, Mattias Ståhlbom.

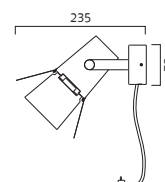
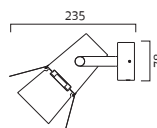
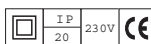

TAK/CEILING 17-19

BORD/TABLE 138

GOLV/FLOOR 144-145

**Utförande:** Skärm av matt opalglas, ribbat matt glas alt. matt opal akryl.

**Montage:** Dikt vägg.

**Anslutning:** Snabbkopplingsplint 5x4mm<sup>2</sup>. Utslagshål för utanpåliggande ledning. Överkopplingsbar.

**Design:** Olle Anderson.

W	SKÄRM/SHADE	ART NR
1x18W/2G11	Opalglas/ <i>Opal glass</i>	4180-1-21
1x18W/2G11	Opalglas/ <i>Opal glass</i>	4180-1-21HFF
1x18W/2G11	Ribbat glas/ <i>Striped glass</i>	4180-1-23
1x18W/2G11	Ribbat glas/ <i>Striped glass</i>	4180-1-23HFF
1x18W/2G11	Akryl/ <i>Acrylic</i>	4180-1-27
1x18W/2G11	Akryl/ <i>Acrylic</i>	4180-1-27HFF

HFF = Dimmbart Driftdon. Fördunklas via SwitchDIM alt. DSI Dali på begäran

HFF = *Dimmable ballast. Dimmable with Switch-DIM or DSI. Dali on request*

**Finish** Shade in matt opal glass, striped matt glass or matt opal acrylic.

**Installation:** On wall.

**Connection:** Snap in terminal block 5x4mm<sup>2</sup>.

**Design:** Olle Anderson.

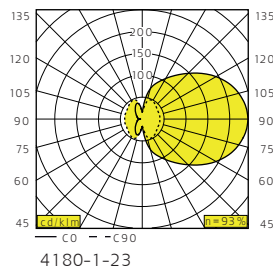
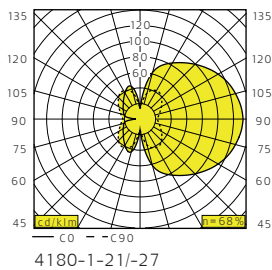
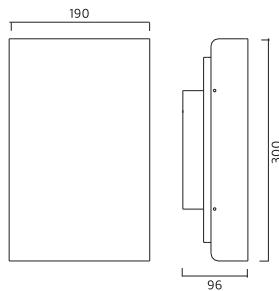



595 gör sig bra i trapphuset, hallen eller i korridoren.

**Utförande:** Zinkgrå lackerad metall och skärm av matt opalglas alt. matt opal akryl.

**Montage:** Dikt tak eller vägg. Distans för utanpåliggande ledning finns som tillbehör.

**Anslutning:** Kopplingsplint 3x4mm<sup>2</sup>. Överkopplingsbar.

**Design:** Inger Thede.

W	SKÄRM/	ART
14W/T5	Glas/Glass	7630-1-21
14W/T5	Glas/Glass	7630-1-21HFF
14W/T5	Akryl/Acrylic	7630-1-27
14W/T5	Akryl/Acrylic	7630-1-27HFF

#### TILLBEHÖR/

Distans för utanpåliggande ledning **97630-1-21**

*Spacer for surface-run mains*

HFF = Dimmbart Driptdon. Fördunklas via SwitchDIM alt. DSI Dali på begäran

HFF = Dimmable ballast. Dimmable with Switch-DIM or DSI. Dali on request

**Finish:** Zincgrey painted steel. Shade in matt opal glass or matt opal acrylic.

**Installation:** Wall or ceiling installation. Spacer for surface-run mains available as accessory.

**Connection:** Snap-in terminal block 3x4mm<sup>2</sup>. Two entry holes.

**Design:** Inger Thede.

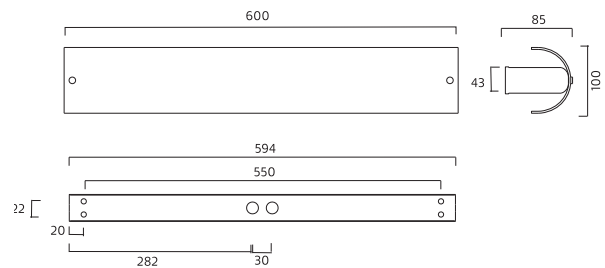
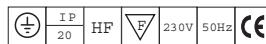

595 gör sig bra i trapphuset, hallen, badrummet eller i korridoren.

**Utförande:** Zinkgrå lackerad metall och skärm av matt opal akryl.

**Montage:** Dikt tak eller vägg. Distans för utanpåliggande ledning finns som tillbehör.

**Anslutning:** Kopplingsplint 3x4mm<sup>2</sup>. Överkopplingsbar.

**Design:** Inger Thede.

W	SKÄRM/	IP	ART NR
14W/T5	Akryll/Acrylic	IP21	7636-1-27
14W/T5	Akryll/Acrylic	IP44	7637-1-27

#### TILLBEHÖR/

Distans för utanpåliggande ledning **97630-1-21**

Spacer for surface-run mains

**Finish:** Zincgrey painted steel. Shade in matt opal acrylic.

**Installation:** Wall or ceiling installation. Spacer for surface-run mains available as accessory.

**Connection:** Snap-in terminal block 3x4mm<sup>2</sup>. Two entry holes.

**Design:** Inger Thede.

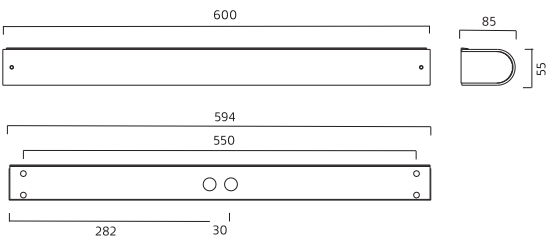
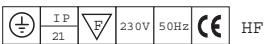



Viva ger ett optimalt ljus för bland annat whiteboard och anslagstavlor. Viva ger ett jämnt och effektivt ljus. Drygt 200 lux i vertikalljus erhålls 2 m under en Viva med 35W bestyckning. Kan rampkopplas i önskad längd.

**Utförande:** Eloxerad aluminium med fast raster. Ovansidan täcks av en löstagbar diffuserande akrylskiva.

**Montage:** På vägg. Väggfästen finns som tillbehör.

**Anslutning:** 2st kopplingsplintar 3x4mm<sup>2</sup>. En i vardera änden. Överkopplingsbar.

**Design:** Per Sundstedt.



W	L/MM	KG	ART
1x14W/T5	725	1,7	7105-1-38
1x14W/T5	725	1,7	7105-1-38HFF
1x21W/T5	900	2,1	7105-2-38
1x21W/T5	900	2,1	7105-2-38HFF
1x28W/T5	1250	2,9	7105-3-38
1x28W/T5	1250	2,9	7105-3-38HFF
2x14W/T5	1450	3,3	7105-4-38
2x14W/T5	1450	3,3	7105-4-38HFF
1x35W/T5	1550	3,4	7105-5-38
1x35W/T5	1550	3,4	7105-5-38HFF
2x21W/T5	1800	4,1	7105-6-38
2x21W/T5	1800	4,1	7105-6-38HFF
2x28W/T5	2450	6,2	7105-7-38
2x28W/T5	2450	6,2	7105-7-38HFF
2x35W/T5	3050	7,9	7105-8-38
2x35W/T5	3050	7,9	7105-8-38HFF

HFF = Dimmbart Driftdon. Fördunklas via SwitchDIM alt. DSI Dali på begäran  
HFF = Dimmable ballast. Dimmable with Switch-DIM or DSI. Dali on request

#### TILLBEHÖR

Gavel höger/End panel right	7317-1-38
Gavel vänster/End panel left	7318-1-38
Väggfäste höger/Wall bracket right	7302-1-38
Väggfäste vänster/Wall bracket left	7303-1-38
Skarvdon/rak koppling/Straight connector	7310-1-38
2,5m kabel med stickpropp/2,5m cable with plug	9000-0-02

**Finish:** Anodized aluminium with rigid louvre. Acrylic cover on the top.

**Installation:** Wall installation. Wall bracket as accessory.

**Connection:** Two terminal blockar 3x4mm<sup>2</sup> - one each end.

Two cable entries.

**Design:** Per Sundstedt.

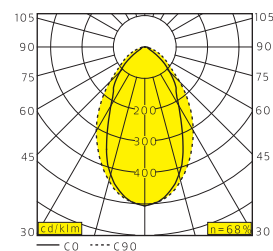
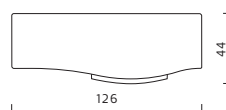

TAK/CEILING 40-41

PENDLAR/PENDANTS 91-96

HYLLA/SHELF 125

Allright ger både uppljus och nedljus genom det prismatiska bländskyddet. Monteras på vägg i korridor, trapphus mm.

**Utförande:** Naturanodiserad aluminium. Prismatiskt bländskydd på ovan- och undersida.

**Montage:** På vägg.

**Anslutning:** Kopplingsplint 3x4mm<sup>2</sup>.

**Design:** Per Sundstedt.

W	B/	IP	KG	ART
1x18W/Gx24q-2	268	IP20	1,6	<b>7413-1-38</b>
2x18W/Gx24q-2	365	IP20	1,9	<b>7413-3-38</b>
1x32W/Gx24q-3	365	IP20	1,9	<b>7413-3-38HFF</b>

HFF = Dimmbart Driftdon. Fördunklas via SwitchDIM alt. DSI Dali på begäran  
HFF = Dimmable ballast. Dimmable with Switch-DIM or DSI. Dali on request

TILLBEHÖR/	ART
Vitt täcklock för endast nedljus bredd 268 mm. Cover for downlight width 268 mm.	<b>97413-1-01</b>
Vitt täcklock för endast nedljus bredd 365 mm. Cover for downlight width 365 mm.	<b>97413-3-01</b>

**Finish:** Anodized aluminium. Prismatic louvre.

**Installation:** Wall installation.

**Connection:** Terminal block 3x4mm<sup>2</sup>.

**Design:** Per Sundstedt.



7413-1-38

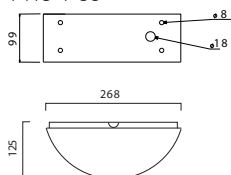

7413-3-38

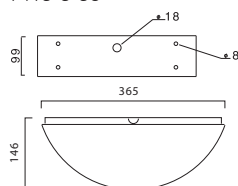

7413-3-38HFF

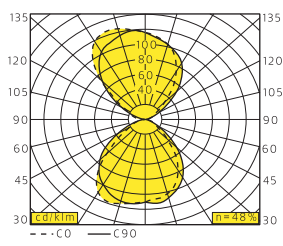
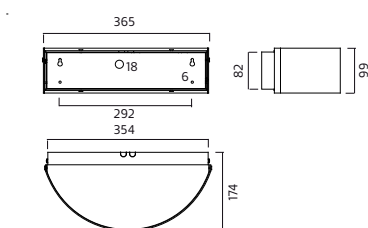

1x18W

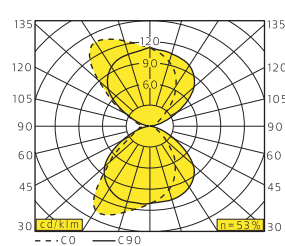

2x18W



TAK/CEILING 20

BADRUM/BATHROOM 121

UTOMHUS/OUTDOOR 165



Stream är en infälld armatur som kan monteras stående eller liggande i vägg, vilket ger en mängd möjligheter för spännande ljussättning.

**Utförande:** Vitlackerad metall. Opalglas. Special längder på begäran.

**Montage:** Infälld i vägg.

**Anslutning:** Kopplingsplint 5x4mm<sup>2</sup>. Överkopplingsbar.

**Design:** R. Aosta.

W	L/MM	KG	ART
28W/T5	1215/1183	3,7	7521-5-01
28W/T5	1215/1183	3,7	7521-5-01HFF
35W/T5	1515/1483	4,2	7521-7-01
35W/T5	1515/1483	4,2	7521-7-01HFF

HFF = Dimmbart Driftdon. Fördunklas via SwitchDIM alt. DSI Dali på begäran  
HFF = Dimmable ballast. Dimmable with Switch-DIM or DSI. Dali on request

**Finish:** White painted steel. Opal glass. Special lengths on request.

**Installation:** Recessed in wall.

**Connection:** Terminal block 5x4mm<sup>2</sup>. Two cable entries.

**Design:** R. Aosta.

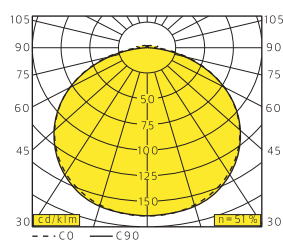
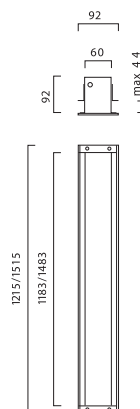

35W

Uppsala kan placeras vertikalt, horisontalt eller i önskad vinkel på vägg. Tre olika ljusriktningar ger oändliga möjligheter för spännande ljussättning.

**Utförande:** Zinkgrå lackerad metall. Ljusutsläpp åt höger alt. vänster fås genom att vända skärmen. Art. 7598 har ljussläpp åt både höger och vänster.

**Montage:** På vägg.

**Anslutning:** Kopplingsplint 3x4mm<sup>2</sup>.

**Design:** Björn Tegnell, Stefan Ståhlgren, White Design.

W	L/MM	LJUS/LIGHT	KG	ART
1x21W/T5	1080	En sida/One side	3,2	<b>7597-1-87</b>
1x21W/T5	1080	En sida/One side	3,2	<b>7597-1-87HFF</b>
1x21W/T5	1080	Båda sidor/Both sides	3,2	<b>7598-1-87</b>
1x21W/T5	1080	Båda sidor/Both sides	3,2	<b>7598-1-87HFF</b>
2x21W/T5	2000	En sida/One side	3,2	<b>7597-7-87</b>
2x21W/T5	2000	En sida/One side	3,2	<b>7597-7-87HFF</b>
2x21W/T5	2000	Båda sidor/Both sides	3,2	<b>7598-7-87</b>
2x21W/T5	2000	Båda sidor/Both sides	3,2	<b>7598-7-87HFF</b>

HFF = Dimmbart Driftdon. Fördunklas via SwitchDIM alt. DSI Dali på begäran  
HFF = Dimmable ballast. Dimmable with Switch-DIM or DSI. Dali on request

TILLBEHÖR/ACCESSORY	ART
Distans för utanpåliggande kabel längd 1080. Spacer for surface-run mains length 1080	<b>97597-1-87</b>
Distans för utanpåliggande kabel längd 2000. Spacer for surface-run mains length 2000	<b>97597-7-87</b>

**Finish:** Zink-grå painted steel. Two versions available - light on one side and light on both sides.

**Installation:** Wall installation.

**Connection:** Terminal block 3x4mm<sup>2</sup>.

**Design:** Björn Tegnell, Stefan Ståhlgren, White Design.

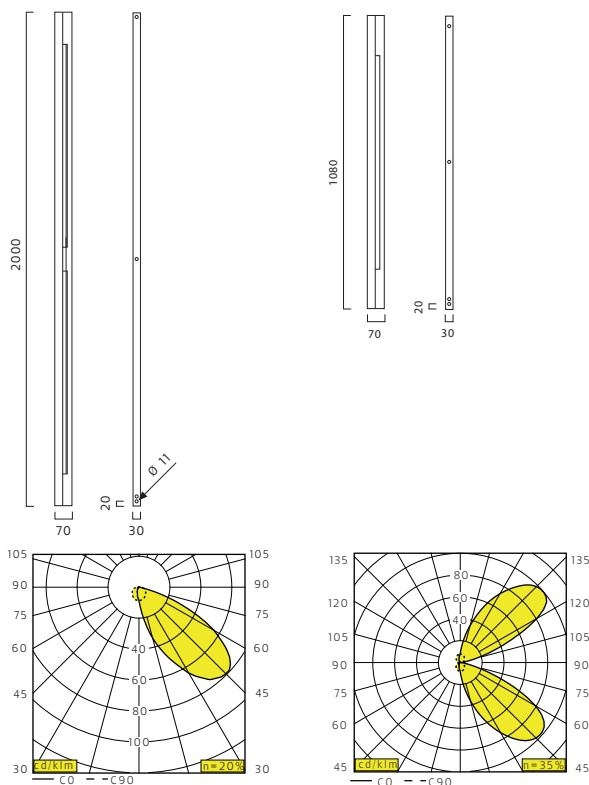

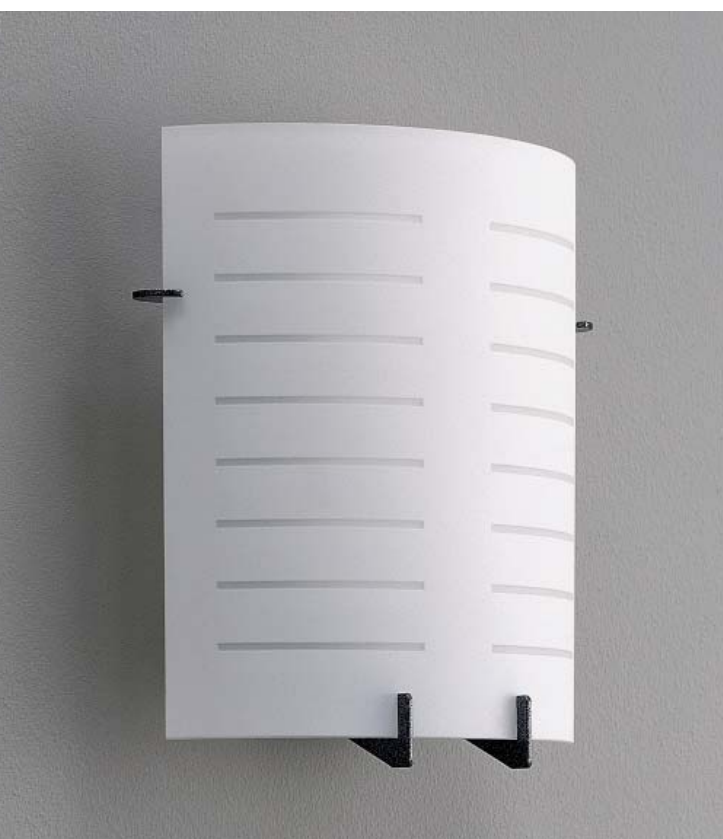
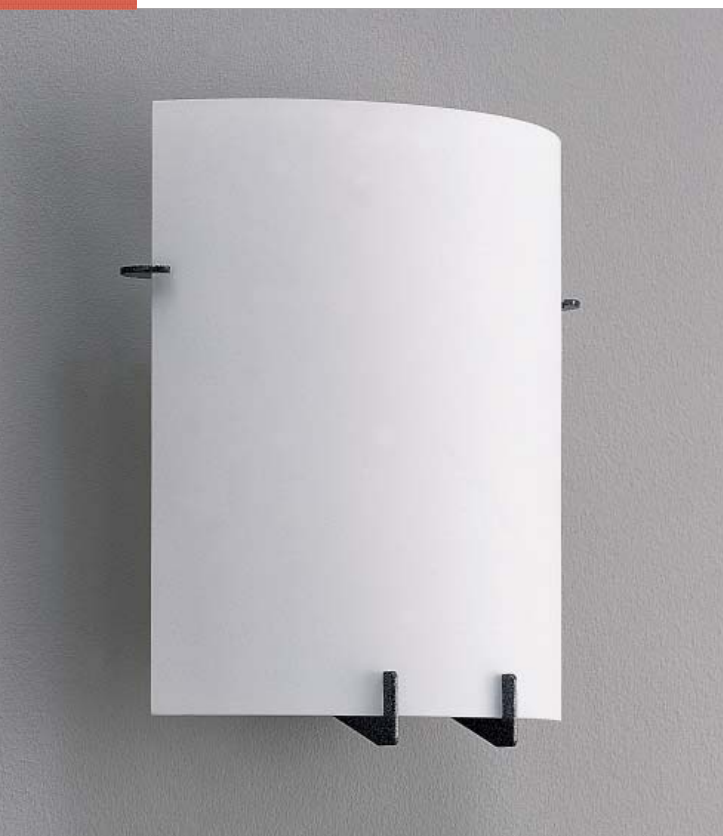

Enkel och stilren väggarmatur som ger ett bra allmänljus. Glasskärmar kan fås med olika mönster. Finns även med inbyggt nödljus.

**Utförande:** Mörkgrå strukturlack. Skärm av matt opalglas alt. matt akryl.

**Montage:** På vägg.

**Anslutning:** Snabbkopplingsplint 5x4mm<sup>2</sup>. Överkopplingsbar.

**Design:** Per Sundstedt.

W	H/MM	SKÄRM/SHADE	KG	ART
11W/2G7	270	Glas/Glass	1,7	4038-1-01HF
11W/2G7	270	Akryll/Acrylic	1,5	4038-1-27HF
11W/2G7	270	Glas/spår/Glass/ribs	1,7	4038-1-31HF
2xE14 max 40W	380	Glas/Glass	2,4	4039-1-01
2xE14 max 40W	380	Akryll/Acrylic	2,3	4039-1-27
2xE14 max 40W	380	Glas/spår/Glass/ribs	2,4	4039-1-31
18W/2G11	290	Glas/Glass	2,5	4040-1-01HF
18W/2G11	290	Glas/Glass	2,5	4040-1-01HFF
18W/2G11	290	Akryll/Acrylic	1,9	4040-1-27HF
18W/2G11	290	Akryll/Acrylic	1,9	4040-1-27HFF
18W/2G11	290	Glas/spår/Glass/ribs	2,5	4040-1-31HF
18W/2G11	290	Glas/spår/Glass/ribs	2,5	4040-1-31HFF
24W/2G11	380	Glas/Glass	2,7	4041-1-01HF
24W/2G11	380	Glas/Glass	2,7	4041-1-01HFF
24W/2G11	380	Akryll/Acrylic	2,3	4041-1-27HF
24W/2G11	380	Akryll/Acrylic	2,3	4041-1-27HFF
24W/2G11	380	Glas/spår/Glass/ribs	2,7	4041-1-31HF
24W/2G11	380	Glas/spår/Glass/ribs	2,7	4041-1-31HFF
18W/2G11	290	Glas/Glass	2,9	4140-1-21HF*
18W/2G11	290	Akryll/Acrylic	2,3	4140-1-27HF*
24W/2G11	380	Glas/Glass	3,1	4141-1-21HF*
24W/2G11	380	Akryll/Acrylic	2,9	4141-1-27HF*
24W/2G11	380	Glas/spår/Glass/ribs	3,1	4141-1-31HF*

HF = Dimmbart Driftdon. Fördunklas via SwitchDIM alt. DSI Dali på begäran  
HFF = Dimmable ballast. Dimmable with Switch-DIM or DSI. Dali on request

\* = Med inbyggt nödljus 1 tim./\* = With emergency pack 1h.



**Finish:** Dark-grey painted steel. Shade in matt opal glass or matt opal acrylic.

**Installation:** Wall installation.

**Connection:** Snap-in terminal block 5x4mm<sup>2</sup>. Two cable entries.

**Design:** Per Sundstedt.

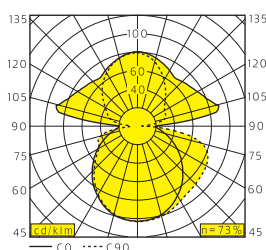

TAK/CEILING 26



PENDLAR/PENDANTS 77



VÄGG/CEILING 112-114

4038

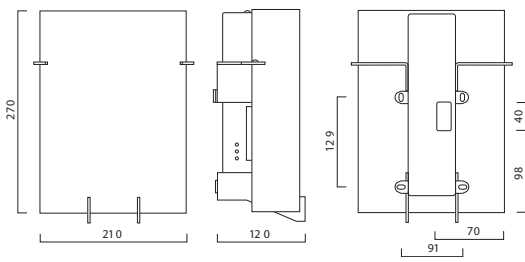

4040

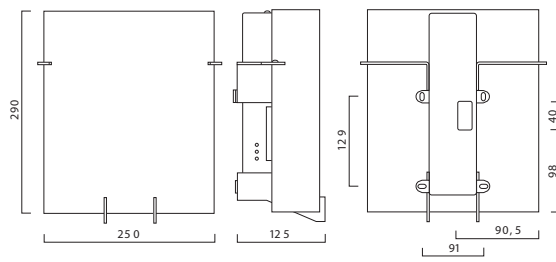

4039/4041

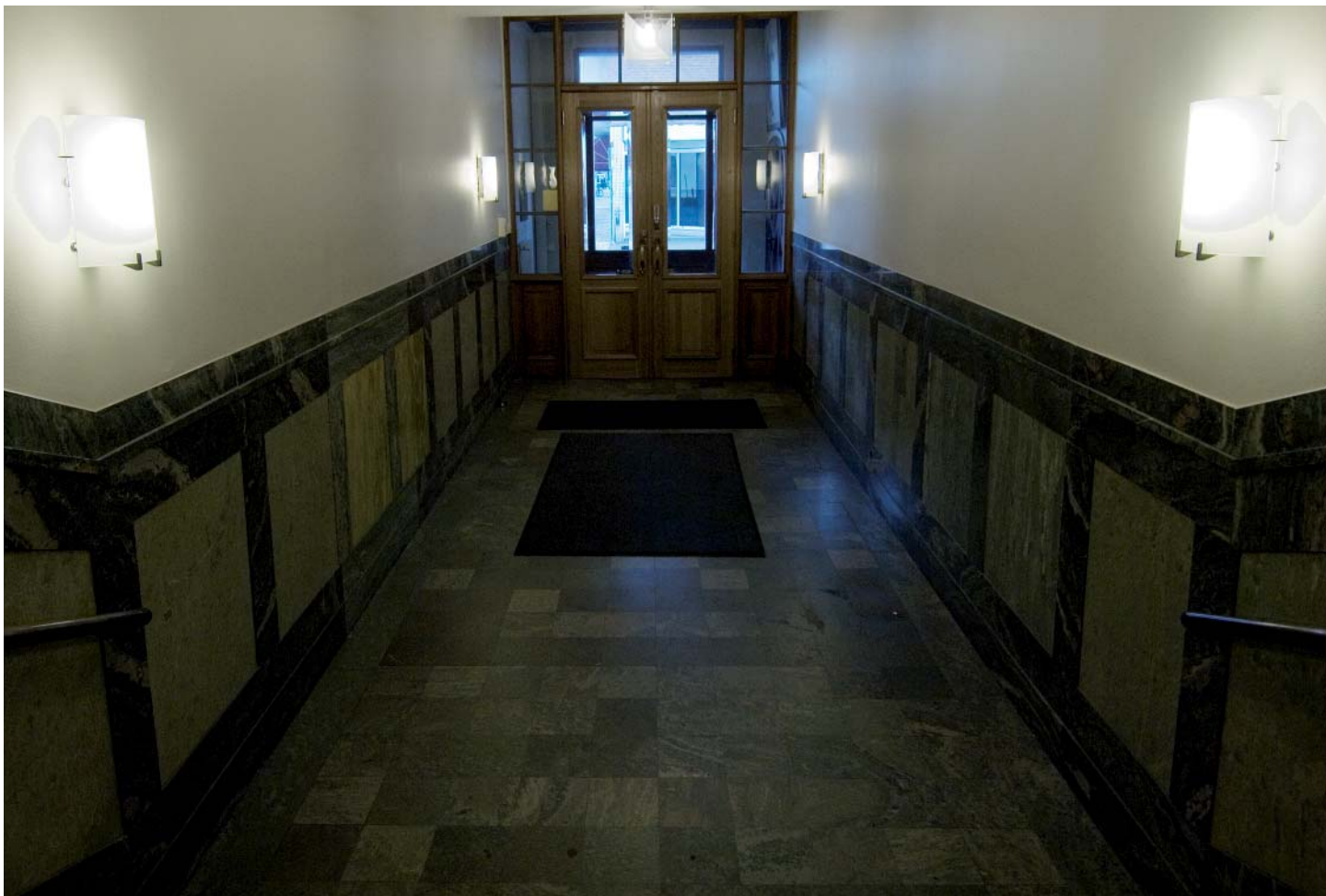
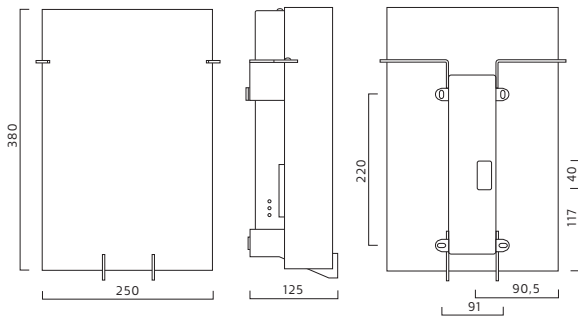

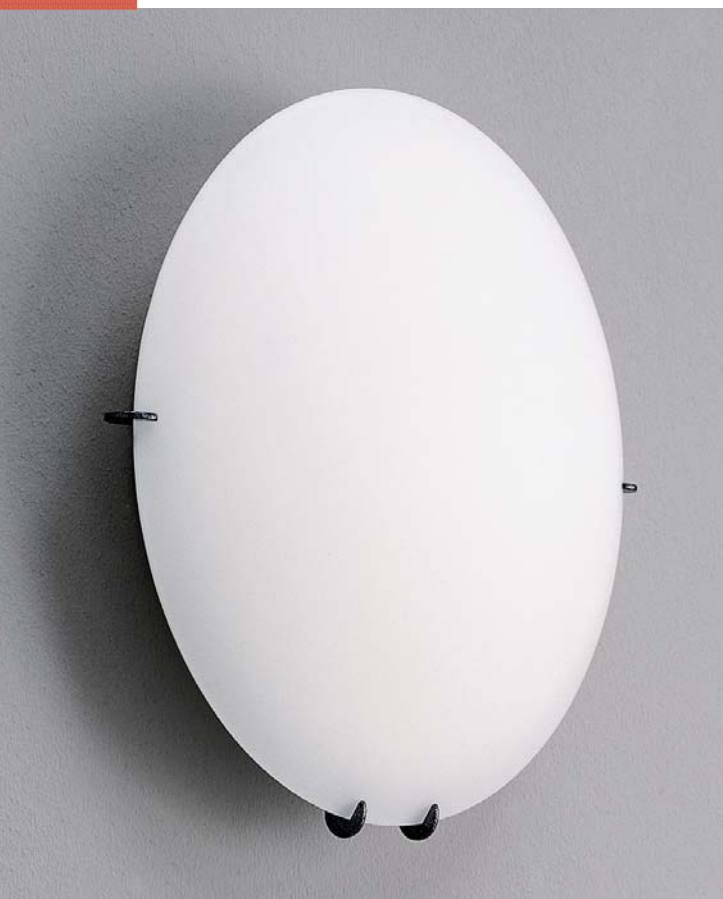

Enkel och stilren väggarmatur som ger ett bra allmänljus. Finns även med inbyggt nödljus.

**Utförande:** Mörkgrå strukturlack. Skärm av matt opalglas alt. matt akryl.

**Montage:** På vägg.

**Anslutning:** Snabbkopplingsplint 5x4mm<sup>2</sup>. Överkopplingsbar. Utslagshål för utanpåliggande ledning.

**Design:** Per Sundstedt.

W	SKÄRM/	KG	ART
18-24W/2G10	Glas/Glass	2,3	4063-1-21HF
24W/2G10	Glas/Glass	2,4	4063-1-21HFF
18-24W/2G10	Akryl/Acrylic	1,6	4063-1-27HF
24W/2G10	Akryl/Acrylic	1,7	4063-1-27HFF
18-24W/2G10	Glas/Glass	2,7	4163-1-21HF*
18-24W/2G10	Akryl/Acrylic	2	4163-1-27HF*

HFF = Dimmbart Driftdon. Fördunklas via SwitchDIM alt. DSI Dali på begäran  
HFF = Dimmable ballast. Dimmable with Switch-DIM or DSI. Dali on request.  
\* = Med inbyggt nödljus 1 tim.J\* = With emergency pack 1h.



**Finish:** Dark-grey painted steel. Shade in matt opal glass or matt opal acrylic.

**Installation:** Wall installation.

**Connection:** Snap-in terminal block 5x4mm<sup>2</sup>. Two cable entries.

Knockout for external mains cable.

**Design:** Per Sundstedt.

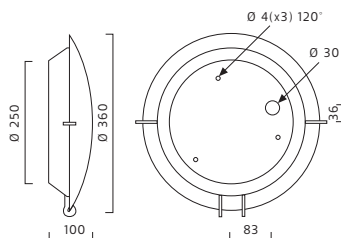

HFF & Nödljus/HFF & Emergency

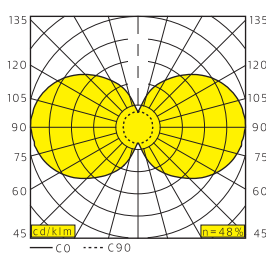
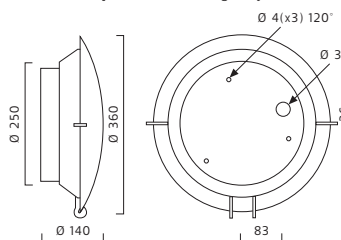

TAK/CEILING 44-48

PENDLAR/PENDANTS 77

VÄGG/CEILING 110-112

Mimmi ger ett effektivt och dekorativt ljus genom sin vita plisserade skärm.  
Lämplig i bland annat korridorer, trapphus, konferensrum, relax mm.

**Utförande:** Grålackerad metall. Vit plisserad skärm.

**Montage:** På vägg.

**Anslutning:** Snabbkopplingsplint 5x4mm<sup>2</sup>. Överkopplingsbar.

Utbrytningsöppning för utanpåliggande kabel.

**Design:** pelikan copenhagen.

W	KG	ART
E14	1,5	4414-1-35
18W/2G11	1,6	4415-1-35HF
18W/2G11	1,6	4415-1-35HFF

HFF = Dimmbart Driftdon. Fördunklas via SwitchDIM alt. DSI Dali på begäran  
HFF = Dimmable ballast. Dimmable with Switch-DIM or DSI. Dali on request.

#### LJUSKÄLLA E14/LIGHT SOURCE E14

18W Halogen Eco	L70026
7W lågenergi/low energy	L70022
1,6W LED	L70027

**Finish:** Grey-painted steel. White pleated shade.

**Installation:** Wall installation.

**Connection:** Snap-in terminal block 5x4mm<sup>2</sup>. Two cable entries. Knockout for external mains cable.

**Design:** pelikan copenhagen.

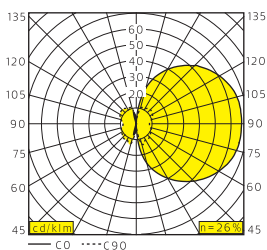
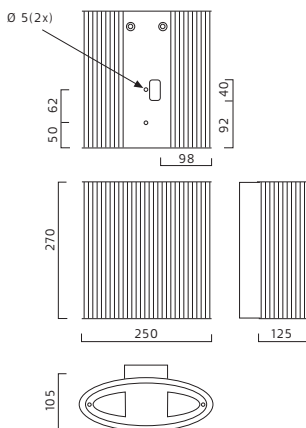

TAK/CEILING 24

PENDLAR/PENDANTS 78-82

GOLV/FLOOR 151

Keps är en utmärkt sängarmatur. Genom att öppna eller stänga skärmen fås ett direktljus eller indirekt ljus på ett behagligt sätt.

**Utförande:** Vitlackerad metall. Tryckströmbrytare på armaturen.

**Montage:** På vägg.

**Anslutning:** Kopplingsplint 3x4mm<sup>2</sup>. Överkopplingsbar.

**Design:** Börge Lindau.

W	KG	ART
E27	1,8	0121-3-01
10-13W/G24q-1	2,1	0225-3-01HF

#### LJUSKÄLLA E27/LIGHT SOURCE E27

42W Halogen Eco	L251715
11W lågenergi/low energy	L70012
7W LED	L70023

**Finish:** White-painted steel. On and off switch.

**Installation:** On Wall.

**Connection:** Terminal-block 3x4mm<sup>2</sup>. Two cable entries.

**Design:** Börge Lindau.

