

TRIO 140-141



LIGHT HOUSE 142



BOTTLE 143



FOTO 144-145



RGB 146



LAST 147



CAN 148



HIDE 149-150



MIMMI 151





Utförande: Vit- alt. svartlackerad aluminium. Detaljer i akryl.

Anslutning: 2,5 m kabel med brytare och stickpropp.

Design: Stig Ahlström 2010.

| W | FÄRG/FINISH | AKRYL/ACRYLIC | ART |
|----------|-------------|---------------|-----------|
| LED 3,5W | Vit/White | Svart/Black | 8066-1-01 |
| LED 3,5W | Svart/Black | Vit/White | 8066-1-06 |

Finish: White or black painted aluminum and diffuser in white or black acrylic.

Installation: Table base or fitting through table.

Connection: 2,5 m cable with switch and plug.

Design: Stig Ahlström 2010.

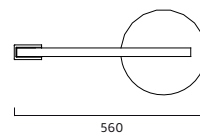
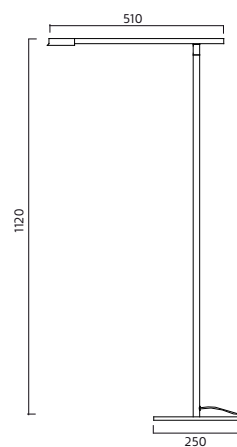
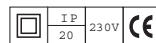

Utförande: Vit- alt. svartlackerad aluminium. Bländskydd i akryl.

Anslutning: 2,5 m kabel med brytare och stickpropp.

Design: Stig Ahlström 2010.

| W | FÄRG/FINISH | AKRYL/ACRYLIC | ART |
|------------|-------------|---------------|-----------|
| 3xLED 3,5W | Vit/White | Svart/Black | 8066-3-01 |
| 3xLED 3,5W | Svart/Black | Vit/White | 8066-3-06 |

Finish: White or black painted aluminum and diffuser in white or black acrylic.

Connection: 2,5 m cable with switch and plug.

Design: Stig Ahlström 2010

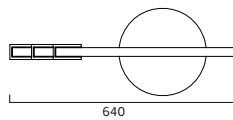
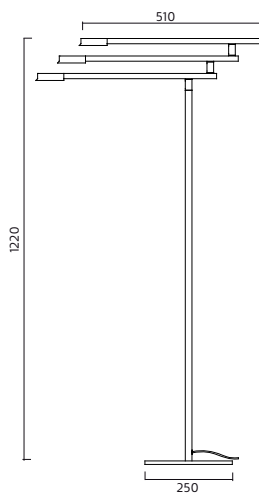



Utförande: Vitlackerad metall.

Anslutning: 2,5 m vit kabel med brytare och stickpropp.

Design: Thomas Sandell 2009.

| W | ART |
|-------------|-----------|
| 18W/Gx24q-2 | 7791-1-01 |
| E27 | 7792-1-01 |

LJUSKÄLLA E27/LIGHT SOURCE E27

| | |
|--------------------------|---------|
| 53W Halogen Eco | L251722 |
| 15W lågenergi/low energy | L70018 |
| 7W LED | L70023 |

Finish: White painted metal. Diffuser in matt akrylic.

Connection: 2,5 m white cable with switch and plug.

Design: Thomas Sandell 2009.

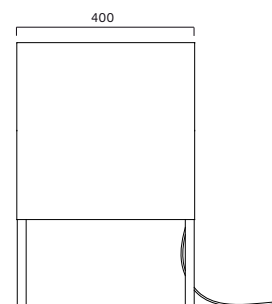
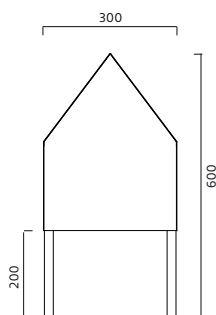
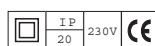

Utförande: Gjuten aluminium och matt opal akryl.

Anslutning: 2,5 m kabel med brytare och stickpropp.

Design: Mattias Ståhlbom 2009.

| W | FÄRG/FINISH | ART |
|-------------|---------------------|-----------|
| 18W/Gx24q-2 | Vit/White | 7731-1-01 |
| 18W/Gx24q-2 | Gul/Yellow | 7731-1-14 |
| 18W/Gx24q-2 | Aluminium/Aluminium | 7731-1-85 |
| E27 | Vit/White | 7733-1-01 |
| E27 | Gul/Yellow | 7733-1-14 |
| E27 | Aluminium/Aluminium | 7733-1-85 |

LJUSKÄLLA E27/LIGHT SOURCE E27

| | |
|--------------------------|---------|
| 42W Halogen Eco | L251715 |
| 11W lågenergi/low energy | L70012 |
| 7W LED | L70023 |

Finish: Cast aluminium and matt opal acrylic.

Connection: 2,5 m cable with switch and plug.

Design: Mattias Ståhlbom 2009.

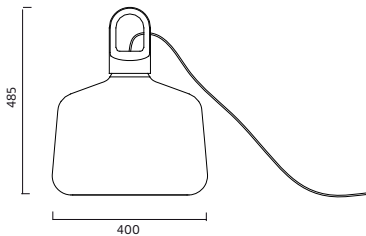
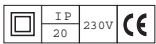

PENDEL/PENDANT 55

BORD/TABLE 132

UTOMHUS/OUTDOOR 164





Utförande: Vit- alt. svartlackerad metall och aluminium. Matt glas. Riktbart armaturhus och höj- och sänkbart stativ. Fyra ställbara avbländningsklaffar.

Anslutning: 2,5 m kabel med fotbrytare och jordad stickpropp.

Design: Thomas Bernstrand, Mattias Ståhlbom 2006.

| W | FÄRG/FINISH | ART |
|-------------|-------------|-----------|
| E27 | Vit/White | 7649-1-01 |
| E27 | Svart/Black | 7649-1-06 |
| 26W/Gx24q-3 | Vit/White | 7650-1-01 |
| 26W/Gx24q-3 | Svart/Black | 7650-1-06 |

TILLBEHÖR/ACCESSORIES

Dimmer, vit. Endast till 7649, 7749. **97649-1-01**

Dimmer, white. Only for 7649, 7749

Dimmer, svart. Endast till 7649, 7749. **97649-1-06**

Dimmer, black. Only for 7649, 7749

LJUSKÄLLA E27/LIGHT SOURCE E27

53W Halogen Eco **L251722**

15W lågenergi/low energy **L70018**

7W LED **L70023**

Finish: Floor lamp with adjustable spotlight. Swivelling and telescopic stem.

Die-casted aluminium. HF ballast as standard.

Connection: 2,5m cable, switch and plug. Dimmer available as accessory.

Design: Thomas Bernstrand, Mattias Ståhlbom 2006.

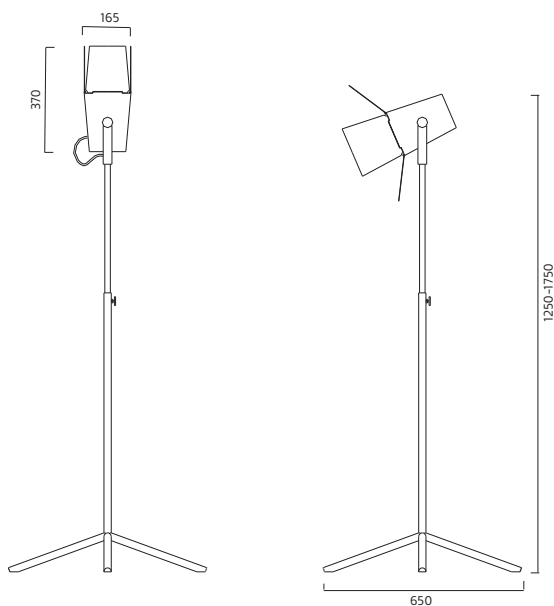
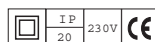

TAK/CEILING 17-19

VÄGG/WALL 104

BORD/TABLE 138

Utförande: Lackerad metall och gjuten aluminium. Riktbart armaturhus. Fyra ställbara avbländningsklaffar.

Anslutning: 2,5 m kabel med brytare och stickpropp. Dimmer på kabel finns som tillbehör. Svart lackerad har svart kabel, övriga har vit kabel.

Design: Thomas Bernstrand, Mattias Ståhlbom.

| W | V | FÄRG/FINISH | ART |
|-----------|-----|---------------|-----------|
| 35W/GU10 | 230 | Vit/White | 7659-1-01 |
| 35W/GU10 | 230 | Svart/Black | 7659-1-06 |
| 35W/GU10 | 230 | Röd/Red | 7659-1-07 |
| 35W/GU10 | 230 | Blå/Blue | 7659-1-08 |
| 35W/GU10 | 230 | Gul/Yellow | 7659-1-14 |
| 35W/GU10 | 230 | Orange/Orange | 7659-1-41 |
| 20W/Gu5,3 | 12 | Vit/White | 7759-1-01 |
| 20W/Gu5,3 | 12 | Svart/Black | 7759-1-06 |
| 20W/Gu5,3 | 12 | Röd/Red | 7759-1-07 |
| 20W/Gu5,3 | 12 | Blå/Blue | 7759-1-08 |
| 20W/Gu5,3 | 12 | Gul/Yellow | 7759-1-14 |
| 20W/Gu5,3 | 12 | Orange/Orange | 7759-1-41 |

| TILLBEHÖR/ACCESSORY | ART |
|--|------------|
| Dimmer, vit. Endast för 35W 230 volt. <i>Dimmer, white. For 35W 230 voltage only.</i> | 97649-1-01 |
| Dimmer, svart. Endast för 35W 230 volt. <i>Dimmer, black. For 35W 230 voltage only.</i> | 97649-1-06 |

ALTERNATIV LJUSKÄLLA GU10/ALTERNATIVE LIGHT SOURCE GU10

| | |
|--------|--------|
| 3W LED | L70024 |
|--------|--------|

Finish: Floor lamp with adjustable spotlight. Painted steel and die-casted aluminium.

Connection: 2,5 m cable, switch and plug. Dimmer available as accessory. Black finish has black cable, other finishes have white cable.

Design: Thomas Bernstrand, Mattias Ståhlbom.

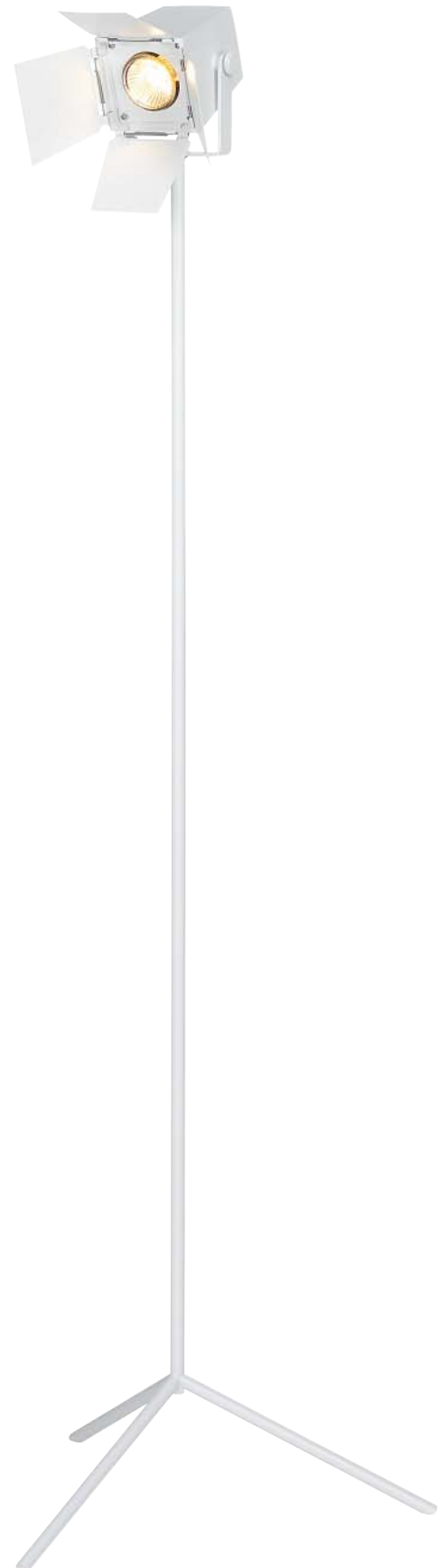
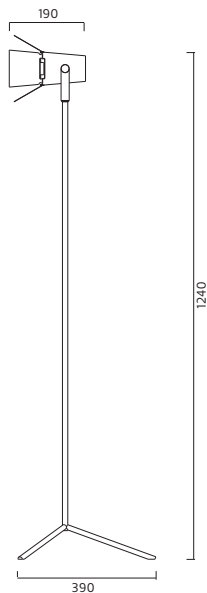

TAKI/CEILING 17-19

VÄGG/WALL 104

BORD/TABLE 138

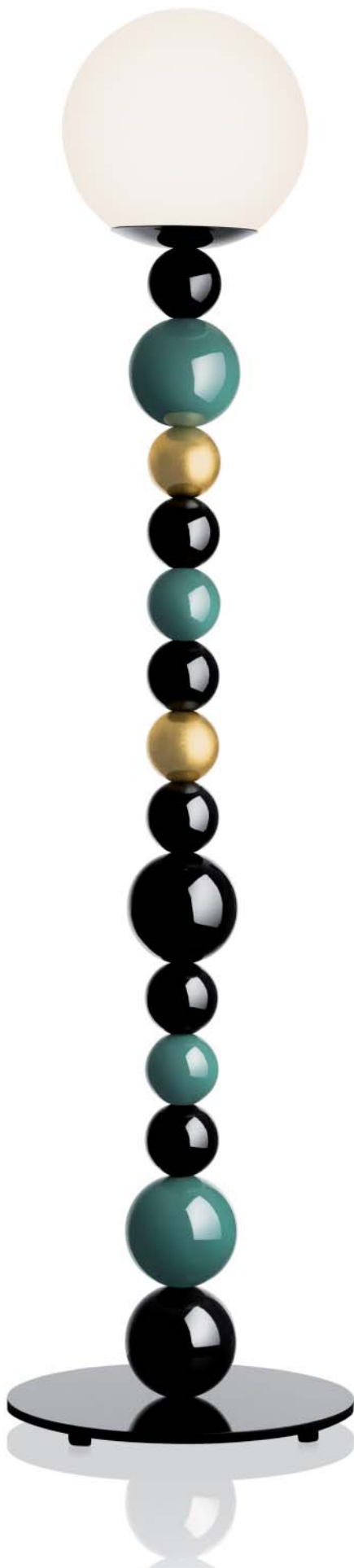

Utförande: Högblanklackerade träkulor. Två kulor med bladguld. Kupa av opalglas och fotplatta i svartlackerad metall.

Anslutning: 2,5 m kabel med brytare och stickpropp.

Design: Fredrik Mattson 2008.

| W | KG | ART |
|---------|-----|-----------|
| 60W/E27 | 6,7 | 7775-3-90 |

LJUSKÄLLA E27/LIGHT SOURCE E27

| | |
|--------------------------|---------|
| 42W Halogen Eco | L251715 |
| 11W lågenergi/low energy | L70012 |
| 7W LED | L70023 |

Finish: Glossy painted wooden balls. Two balls with gold leaf. Shade in opal glass. Base in black glossy painted metal.

Connection: 2,5 m cable with switch and plug.

Design: Fredrik Mattson 2008.

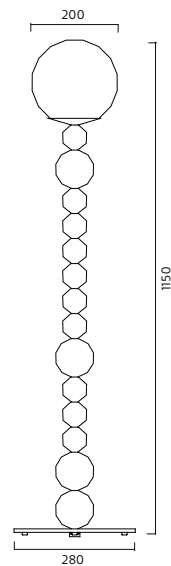
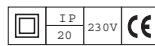

Utförande: Vit eller svartlackerad aluminium. Andra färger på begäran.
 Lysrör - blank reflektor. Glödljus - utan reflektor. Grovt nätraster. Skärmen är vinklingsbar.
 Anslutning: 2,5 m kabel med brytare och stickpropp.
 Design: Mattias Ståhlbom 2007.

| W | FÄRG/FINISH | ART |
|--------------|-------------|-----------|
| 26-42W/Gx24q | Vit/White | 7785-1-01 |
| 26-42W/Gx24q | Svart/Black | 7785-1-06 |
| E27 | Vit/White | 7786-1-01 |
| E27 | Svart/Black | 7786-1-06 |

LJUSKÄLLA E27/LIGHT SOURCE E27

| | |
|--------------------------|---------|
| 53W Halogen Eco | L251722 |
| 15W lågenergi/low energy | L70018 |
| 7W LED | L70023 |

Finish: Aluminium, painted white or black. Other colours on request. Adjustable shade. Compact fluorescent - with metalized reflector. Incandescent - without reflector.

Connection: 2,5 m cable, switch and plug.

Design: Mattias Ståhlbom.

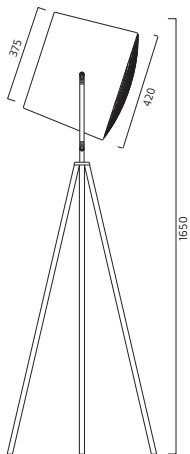

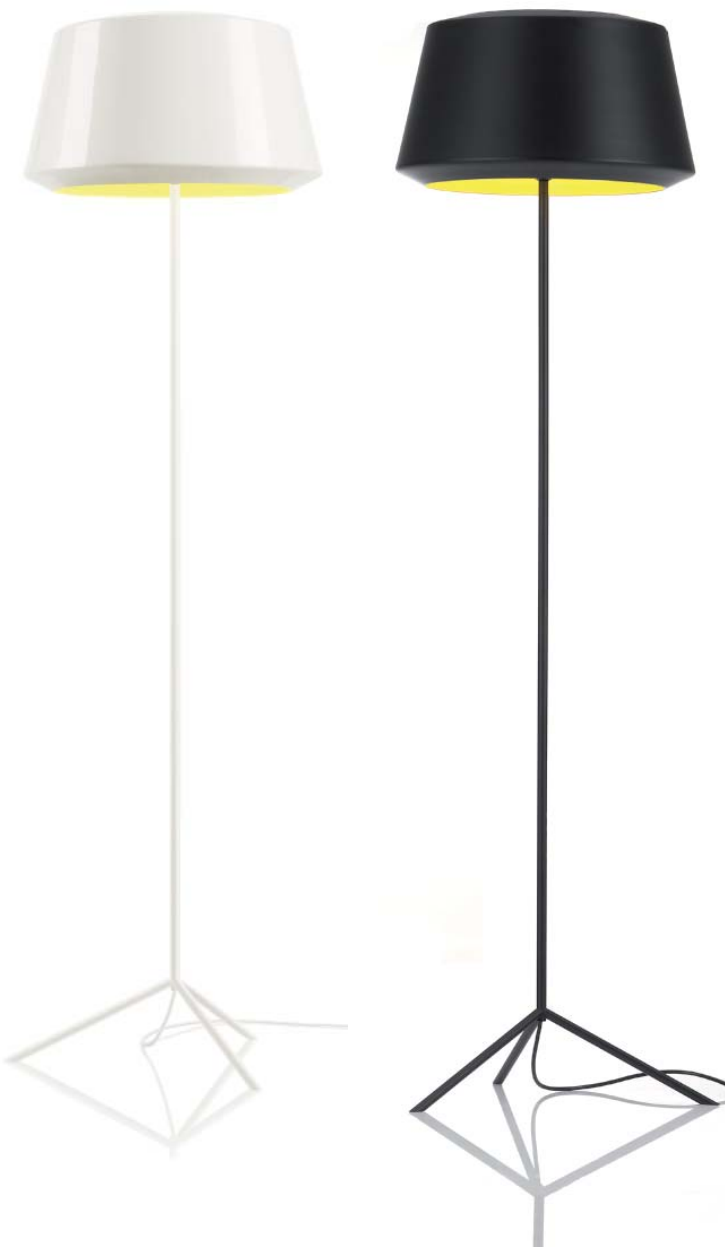

Utförande: Vit eller svartlackerad aluminium. Med gul effektfärgad insida.

Anslutning: 2,5 m kabel med brytare och stickpropp.

Design: Mattias Ståhlbom.

| W | FÄRG/FINISH | KG | ART |
|-----|------------------------|-----|-----------|
| E27 | Vit/Gul/White/Yellow | 2,5 | 7512-1-01 |
| E27 | Svart/Gul/Black/Yellow | 2,5 | 7512-1-06 |

LJUSKÄLLA E27/LIGHT SOURCE E27

53W Halogen Eco L251722

15W lågenergi/low energy L70018

7W LED L70023

Finish: White or black enamelled aluminium and steel. With yellow inside.

Connection: 2,5 m cable with switch and plug.

Design: Mattias Ståhlbom.

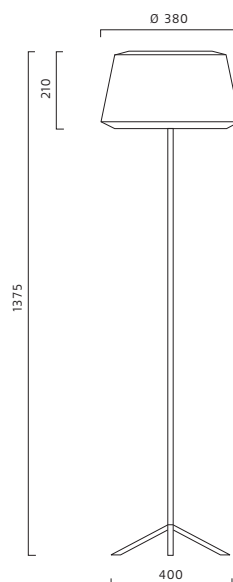
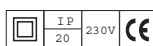

Utförande: Vit- eller svartlackerad aluminium och metall. Innerskärm av opal akryl. Innsida där hela opalkupan av vit akryl lyser utom i utförande med reflektor, då den är öppen. Andra färger på begäran.

Anslutning: 2,5m vit kabel med fotströmbrytare och stickpropp. Vid svart modell svart kabel.

Design: Thomas Bernstrand.

| W | FÄRG/FINISH | ART |
|--------------|--|-----------|
| 26-42W/Gx24q | Vit/White | 7382-1-01 |
| 26-42W/Gx24q | Svart/Black | 7382-1-06 |
| 26-42W/Gx24q | Vit/White Med reflektor/With reflector | 7383-1-01 |
| 26-42W/Gx24q | Svart/Black Med reflektor/With reflector | 7383-1-06 |
| E27 max 42W | Vit/White | 7387-1-01 |
| E27 max 42W | Svart/Black | 7387-1-06 |

Finish: White or black-painted steel. With hidden light source behind opal acrylic diffuser, model with reflector is open. Other colors on request.

Connection: 2,5m cable with switch and plug.

Design: Thomas Bernstrand.

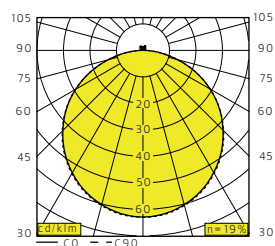
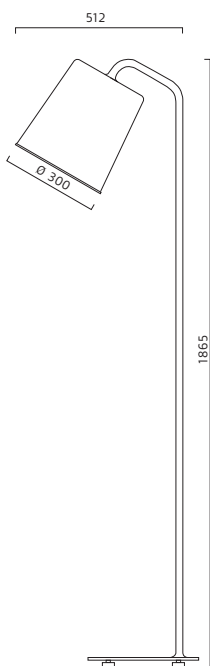

Utan reflektor/Without reflector

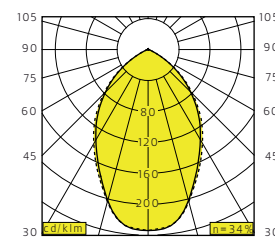

Med reflektor/With reflector

HIDE gullackerad med reflektor
HIDE in yellow with reflector

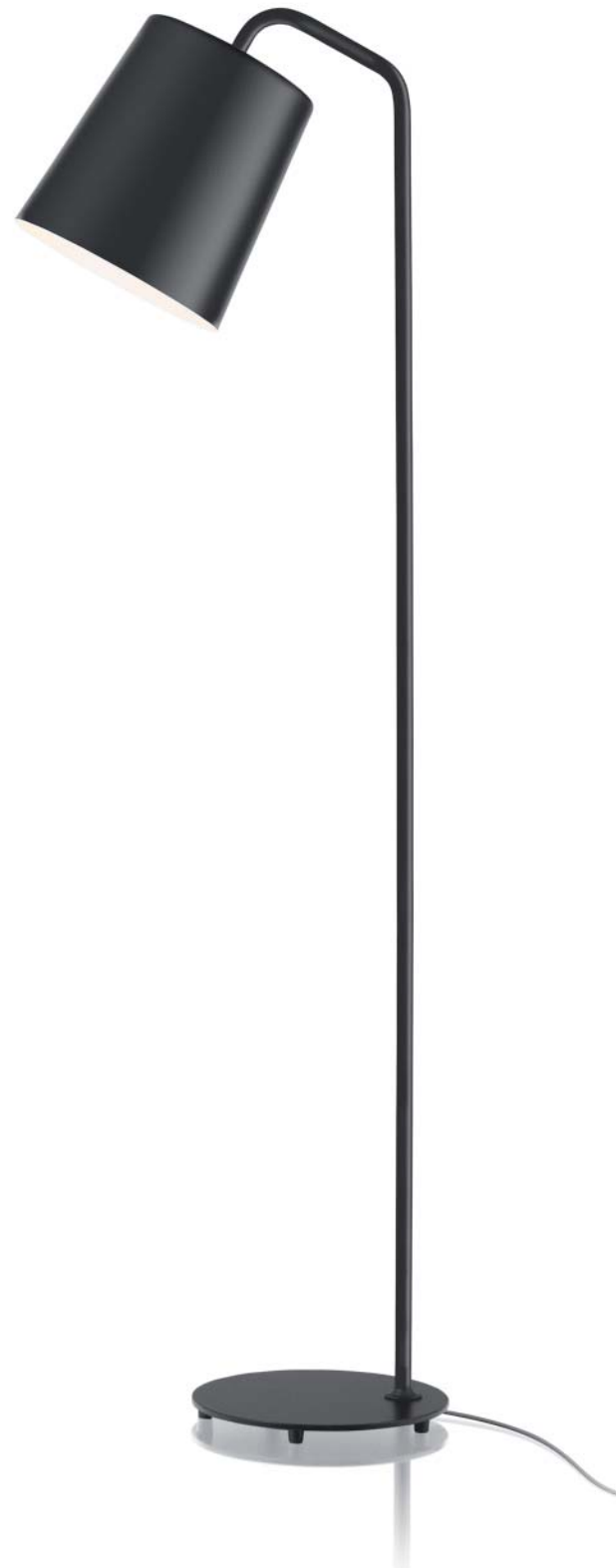

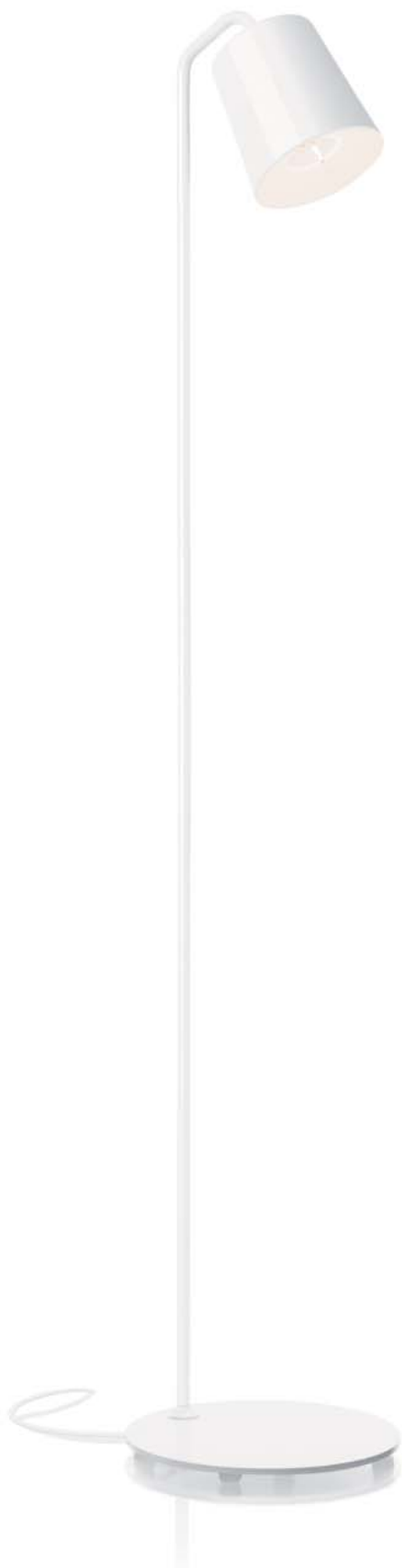

Utförande: Vit- eller svartlackerad aluminium och metall. Innerskärm av opal akryl.

Anslutning: 2,5m vit kabel med fotströmbrytare och stickpropp. Vid svart modell svart kabel.

Design: Thomas Bernstrand.

| W | FÄRG/FINISH | ART |
|----------|-------------|-----------|
| 35W/GU10 | Vit/White | 7487-1-01 |
| 35W/GU10 | Svart/Black | 7487-1-06 |

ALTERNATIV LJUSKÄLLA GU10/ALTERNATIVE LIGHT SOURCE GU10

| | |
|--------|--------|
| 3W LED | L70024 |
|--------|--------|

Finish: White or black-painted steel. With hidden light source behind opal acrylic diffuser.

Connection: 2,5m cable with switch and plug.

Design: Thomas Bernstrand.

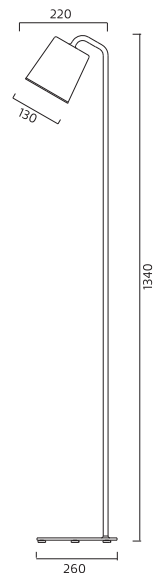
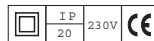

Utförande: Grålackerad metall. Vit plisserad skärm. Finns med eller utan uppljus PAR 38, 80W.

Anslutning: 2,5m kabel med stickpropp och brytare.

Design: pelikan copenhagen.

| W | UPPLIGHT | H/MM | KG | ART |
|----------|--------------------------|------|----|-----------|
| 4x14W/T5 | 1x80W/Par 38 | 1900 | 25 | 4444-1-35 |
| 4x14W/T5 | Inget uppljus/No uplight | 1900 | 24 | 4447-1-35 |
| 2xE27 | Inget uppljus/No uplight | 1600 | 20 | 4460-1-35 |

LJUSKÄLLA E27/LIGHT SOURCE E27

| | |
|--------------------------|---------|
| 53W Halogen Eco | L251722 |
| 15W lågenergi/low energy | L70018 |
| 7W LED | L70023 |

Finish: Grey enamelled steel. White pleated shade. Available with or without uplight PAR 38, 80W.

Connection: 2.5m cable and plug.

Design: pelikan copenhagen.

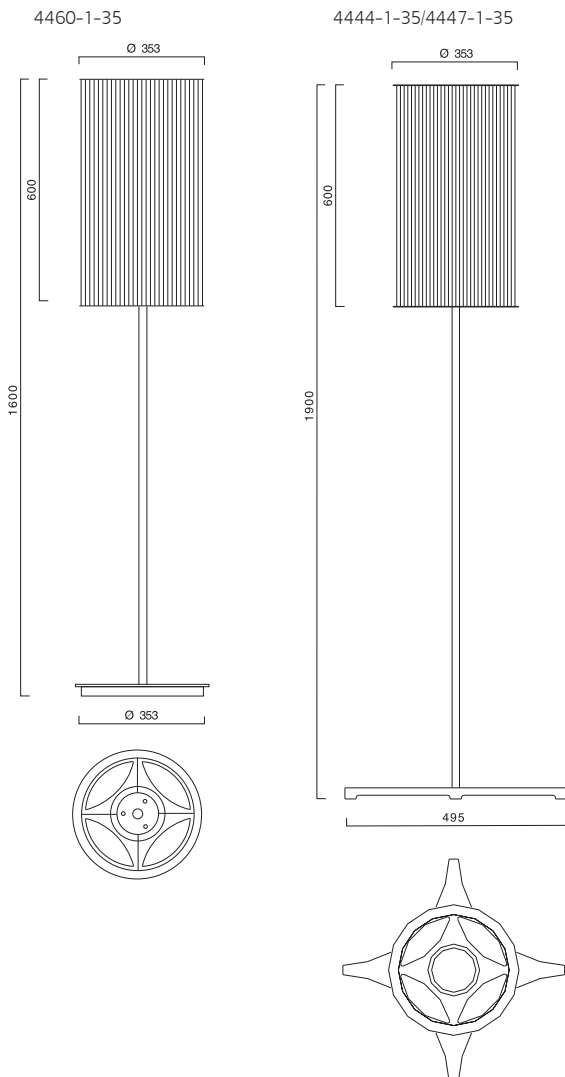

TAK/CEILING 24

PENDLAR/PENDANTS 78-82

VÄGG/WALL 115

